

DOMOCLICK®
HEATING CABLE CONNECTOR

For ELTRACE Self Limiting Heating Cable

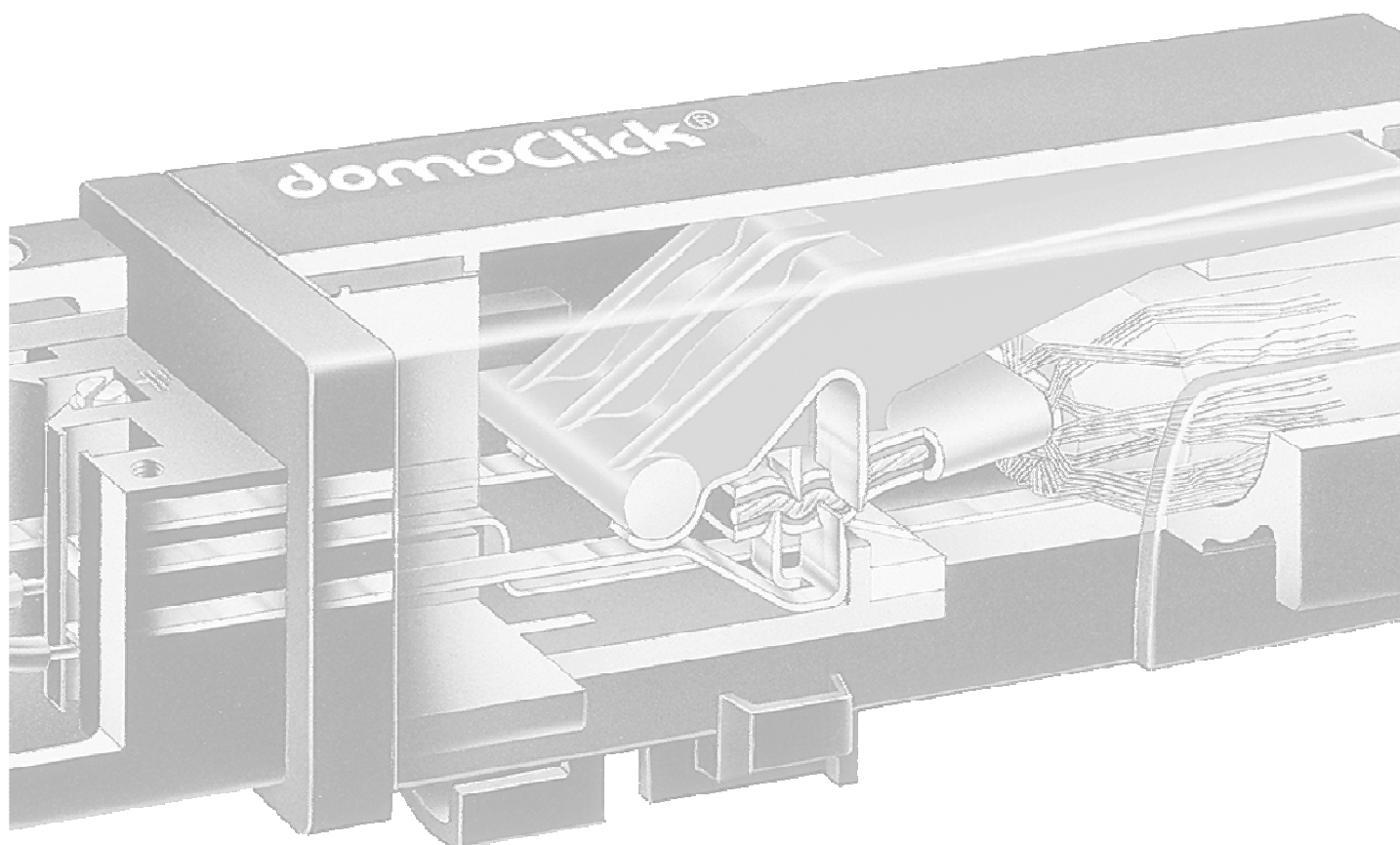

DOMOCLICK® FAST CONNECTOR

EASY

Eltrace heating tapes are supplied and connected between themselves with a minimum of manipulations. Only a knife is needed to strip the band ends. The different clicks are made up of only three parts.

SURE

The mounting stages are visible and easily controllable. The upper and lower blades guarantee a sure contact.

FAST

It takes only a few minutes to assemble the Click, for it involves only four stages:

1. Insert the band into the cover and the metal cone
2. Strip the band end.
3. Insert the heating tape into the Click.
4. Push the lever and shut the cover.

Table of Contents

DHB-100.....	3
Connection set with electrical supply for the junction between the heating tape and the supply cable.	
DHB-101.....	4
Junction set for the junction between two heating tapes (for example for extending a circuit).	
DHB-102.....	5
Junction set with electrical supply for the junction between two heating tapes and the supply cable.	
DHB-103.....	6
DomoClick® T derivation set for the junction between three heating tapes.	
DHB-104.....	7
T derivation set with electrical supply for the junction between three heating tapes and the supply cable	
DHB-105.....	8
DomoClick® T derivation set for the junction between three heating tapes for layer distribution.	
DHB-400.....	9
End cap	
CONVENTIONAL CONNECTION AND JUNCTION TECHNOLOGY.....	10
EQUIVALENCES.....	11
ACCESSORIES.....	12
ASSEMBLY.....	13

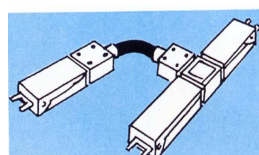
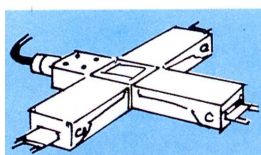
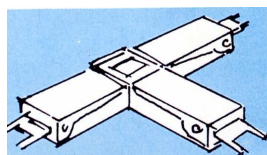
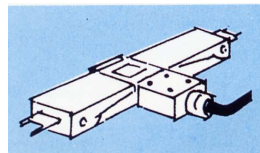
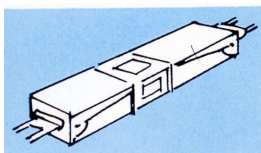
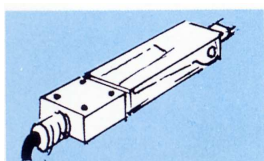

DOMOCLICK® FAST CONNECTOR

DOMOCLICK® - DHB-100



CONNECTION SET WITH ELECTRICAL SUPPLY

Connection set with electrical supply for the junction between the ELTRACE heating cable and the supply cable. Box and cover in polyamid, DomoClick Heating Cable Connector, Ligature, Incorporated electrical connection including cable gland PG 16, Stirrups for wall mounting, CE

COMPOSITION

Incorporated electric supply box
 DomoClick Heating Cable Connector
 1 terminal
 2 heat-resistant ligatures
 2 stirrups for wall mounting
 Self-adhesive labels "electric supply" and "terminal"

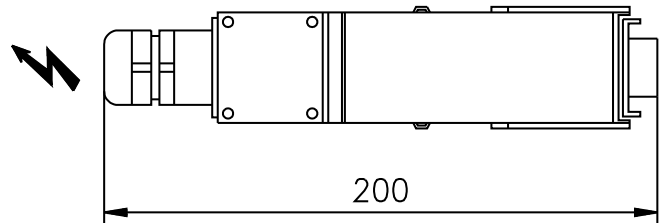

EASY

Eltrace heating tapes are supplied and connected between themselves with a minimum of manipulations. Only a knife is needed to strip the band ends. The different clicks are made up of only three parts.

SURE

The mounting stages are visible and easily controllable. The upper and lower blades guarantee a sure contact.

FAST

It takes only a few minutes to assemble the Click, for it involves only four stages:

1. Insert the band into the cover and the metal cone
2. Strip the band end.
3. Insert the heating tape into the Click.
4. Push the lever and shut the cover.

INSTALLATION PRESCRIPTIONS

The installation of bands, connections to DomoClick® connectors to connection boxes will be carried out according to the rules of the trade.

Before going ahead with work on electric tracers, care will be taken to isolate them from the mains.

The DomoClick® connection and junction techniques are approved if used together with self-adjusting Eltrace heating tapes. Eltrace guarantees correct working only in relation with the mentions heating tapes.

Through the direct mounting onto the pipe, DomoClick® uses less heating tape.

As a general rule, DomoClick® is fixed to the pipe with the supplied ligatures. DomoClick® can also be fixed to the wall with supplied stirrups.

The supply cable is to be directly connected into the DomoClick®. Any exterior supply, junction or derivation box is thus avoided.

In anti-frost installations for gutters, DomoClick® must not be installed in a gutter or on the roof, but in a sheltered position under the roof or eave.

DomoClick® can be installed directly on pipes with a service temperature of less than 70°C. Short periods at 80°C are admitted. Important : for admitted temperatures of heating tapes, refer to the technical data

DomoClick® incorporated into pipe insulation. All supply points, junctions and terminals must remain accessible. Electrical supply points and terminals must be indicated with the supplied self-adhesive labels.

QUALIFICATIONS PRODUITS

Certifications CE



DOMOCLICK® - DHB-101

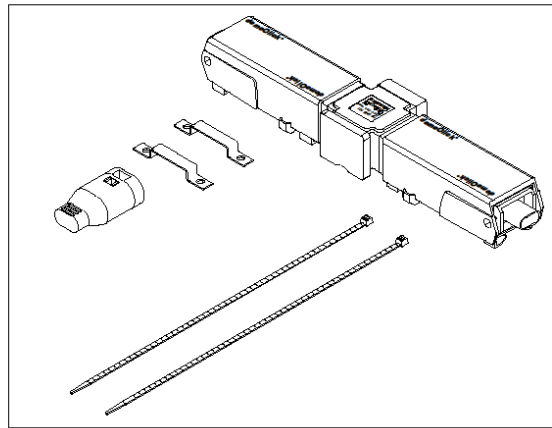

DOMOCLICK JUNCTION SET WITH 1 TERMINAL DOMOCLICK CONNECTOR

Box and cover in polyamid, Ligature, Incorporated electrical connection including cableglad PG 16, Stirrups for wall mounting CE

COMPOSITION

- 1 junction
- 1 terminal
- 2 heat-resistant ligatures
- 2 stirrups for wall mounting
- self-adhesive labels “electric supply” and “terminal”

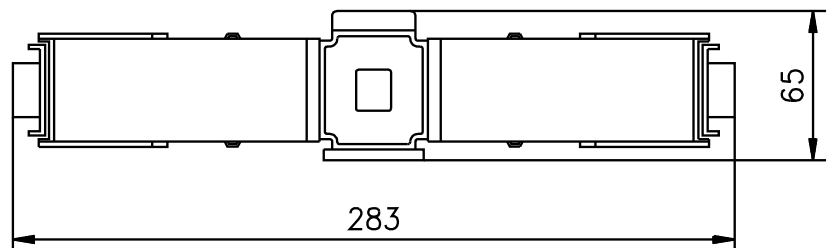

EASY

Eltrace heating tapes are supplied and connected between themselves with a minimum of manipulations. Only a knife is needed to strip the band ends. The different clicks are made up of only three parts.

SURE

The mounting stages are visible and easily controllable. The upper and lower blades guarantee a sure contact.

FAST

It takes only a few minutes to assemble the Click, for it involves only four stages:

1. Insert the band into the cover and the metal cone
2. Strip the band end.
3. Insert the heating tape into the Click.
4. Push the lever and shut the cover.

INSTALLATION PRESCRIPTIONS

The installation of bands, connections to DomoClick® connectors to connection boxes will be carried out according to the rules of the trade. Before going ahead with work on electric tracers, care will be taken to isolate them from the mains. The DomoClick® connection and junction techniques are approved if used together with self-adjusting Eltrace heating tapes. Eltrace guarantees correct working only in relation with the mentions heating tapes. Through the direct mounting onto the pipe, DomoClick® uses less heating tape. As a general rule, DomoClick® is fixed to the pipe with the supplied ligatures. DomoClick® can also be fixed to the wall with supplied stirrups. The supply cable is to be directly connected into the DomoClick®. Any exterior supply, junction or derivation box is thus avoided. In anti-frost installations for gutters, DomoClick® must not be installed in a gutter or on the roof, but in a sheltered position under the roof or eave. DomoClick® can be installed directly on pipes with a service temperature of less than 70°C. Short periods at 80°C are admitted. Important : for admitted temperatures of heating tapes, refer to the technical data DomoClick® incorporated into pipe insulation. All supply points, junctions and terminals must remain accessible. Electrical supply points and terminals must be indicated with the supplied self-adhesive labels.

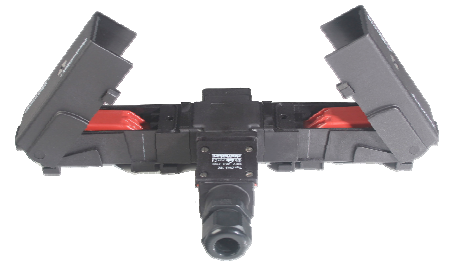

DOMOCLICK® - DHB-102

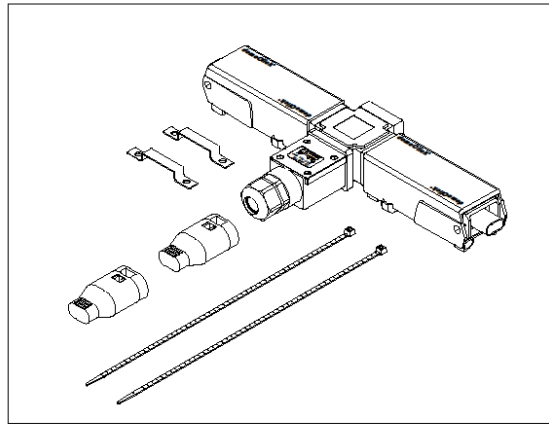

JUNCTION SET WITH ELECTRICAL SUPPLY FOR THE JUNCTION BETWEEN TWO HEATING TAPES AND THE SUPPLY CABLE
 Box and cover in polyamid, Ligature, Incorporated electrical connection including cablegland PG 16, Stirrups for wall mounting CE

COMPOSITION

- Incorporated electric supply box
- Domoclick heating cable connector
- 2 terminals
- 2 heat-resistant ligatures
- 2 stirrups for wall mounting
- self-adhesive labels "electric supply" and "terminal"

EASY

Eltrace heating tapes are supplied and connected between themselves with a minimum of manipulations. Only a knife is needed to strip the band ends. The different clicks are made up of only three parts.

SURE

The mounting stages are visible and easily controllable. The upper and lower blades guarantee a sure contact.

FAST

It takes only a few minutes to assemble the Click, for it involves only four stages:

1. Insert the band into the cover and the metal cone
2. Strip the band end.
3. Insert the heating tape into the Click.
4. Push the lever and shut the cover.

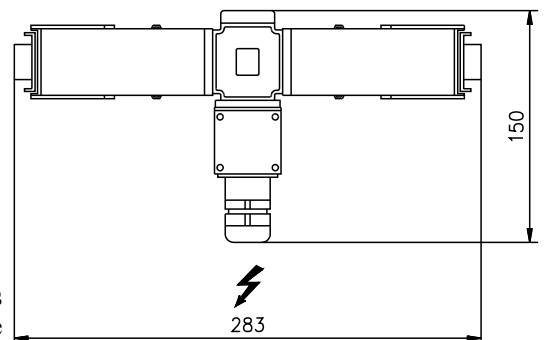

INSTALLATION PRESCRIPTIONS

The installation of bands, connections to DomoClick® connectors to connection boxes will be carried out according to the rules of the trade. Before going ahead with work on electric tracers, care will be taken to isolate them from the mains. The DomoClick® connection and junction techniques are approved if used together with self-adjusting Eltrace heating tapes. Eltrace guarantees correct working only in relation with the mentions heating tapes. Through the direct mounting onto the pipe, DomoClick® uses less heating tape. As a general rule, DomoClick® is fixed to the pipe with the supplied ligatures. DomoClick® can also be fixed to the wall with supplied stirrups. The supply cable is to be directly connected into the DomoClick®. Any exterior supply, junction or derivation box is thus avoided. In anti-frost installations for gutters, DomoClick® must not be installed in a gutter or on the roof, but in a sheltered position under the roof or eave. DomoClick® can be installed directly on pipes with a service temperature of less than 70°C. Short periods at 80°C are admitted. Important : for admitted temperatures of heating tapes, refer to the technical data DomoClick® incorporated into pipe insulation. All supply points, junctions and terminals must remain accessible. Electrical supply points and terminals must be indicated with the supplied self-adhesive labels.

QUALIFICATIONS PRODUITS

Certifications CE



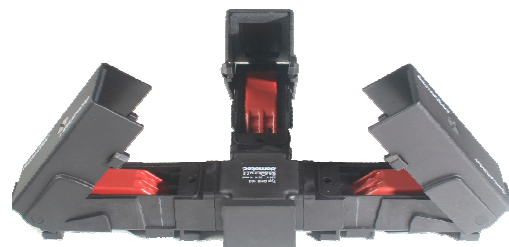

DOMOCLICK® - DHB-103

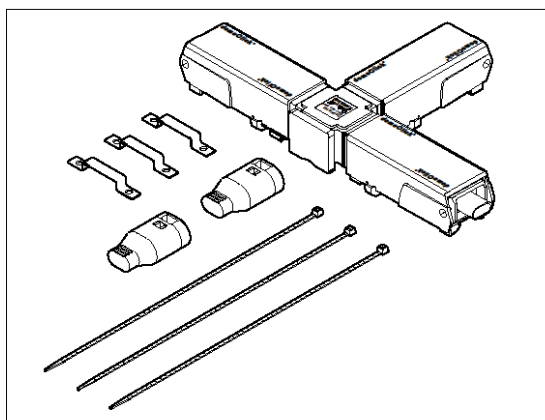

DOMOCLICK DHB-103 T DERIVATION

DomoClick® T derivation set for the junction between three heating tapes (for example for a T derivation or extending a circuit).

COMPOSITION

1. T derivation
2. 2 terminals
3. 3 heat-resistant ligatures
4. 3 stirrups for wall mounting
5. Self-adhesive labels “electric supply” and “terminal”

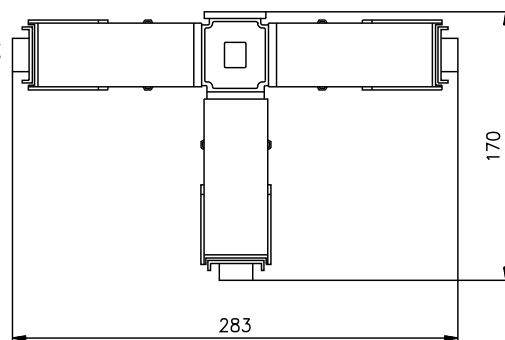

EASY

Eltrace heating tapes are supplied and connected between themselves with a minimum of manipulations. Only a knife is needed to strip the band ends. The different clicks are made up of only three parts.

SURE

The mounting stages are visible and easily controllable. The upper and lower blades guarantee a sure contact.

FAST

It takes only a few minutes to assemble the Click, for it involves only four stages:

1. Insert the band into the cover and the metal cone
2. Strip the band end.
3. Insert the heating tape into the Click.
4. Push the lever and shut the cover.

INSTALLATION PRESCRIPTIONS

The installation of bands, connections to DomoClick® connectors to connection boxes will be carried out according to the rules of the trade. Before going ahead with work on electric tracers, care will be taken to isolate them from the mains. The DomoClick® connection and junction techniques are approved if used together with self-adjusting Eltrace heating tapes. Eltrace guarantees correct working only in relation with the mentions heating tapes. Through the direct mounting onto the pipe, DomoClick® uses less heating tape. As a general rule, DomoClick® is fixed to the pipe with the supplied ligatures. DomoClick® can also be fixed to the wall with supplied stirrups. The supply cable is to be directly connected into the DomoClick®. Any exterior supply, junction or derivation box is thus avoided. In anti-frost installations for gutters, DomoClick® must not be installed in a gutter or on the roof, but in a sheltered position under the roof or eave. DomoClick® can be installed directly on pipes with a service temperature of less than 70°C. Short periods at 80°C are admitted. Important : for admitted temperatures of heating tapes, refer to the technical data. DomoClick® incorporated into pipe insulation. All supply points, junctions and terminals must remain accessible. Electrical supply points and terminals must be indicated with the supplied self-adhesive labels.

QUALIFICATIONS PRODUITS

Certifications CE



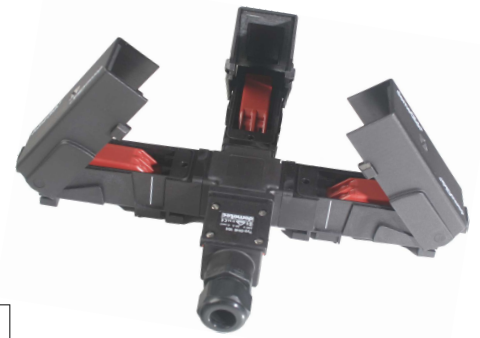

DOMOCLICK® - DHB-104

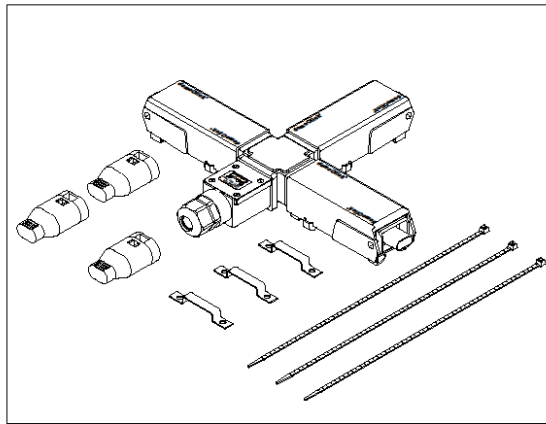

T DERIVATION SET WITH ELECTRICAL

DomoClick® T derivation set with electrical supply for the junction between three heating tapes and the supply cable

Box and cover in polyamid, Ligature, Incorporated electrical connection including cablegland PG 16 for DHB 104, Stirrups for wall mounting CE

COMPOSITION

1. T derivation with electrical supply
2. Three terminations
3. Three heat-resistant ligatures
4. Three stirrups for wall mounting
5. Self-adhesive labels “electric supply” and “terminal”

EASY

Eltrace heating tapes are supplied and connected between themselves with a minimum of manipulations. Only a knife is needed to strip the band ends. The different clicks are made up of only three parts.

SURE

The mounting stages are visible and easily controllable. The upper and lower blades guarantee a sure contact.

FAST

It takes only a few minutes to assemble the Click, for it involves only four stages:

1. Insert the band into the cover and the metal cone
2. Strip the band end.
3. Insert the heating tape into the Click.
4. Push the lever and shut the cover.

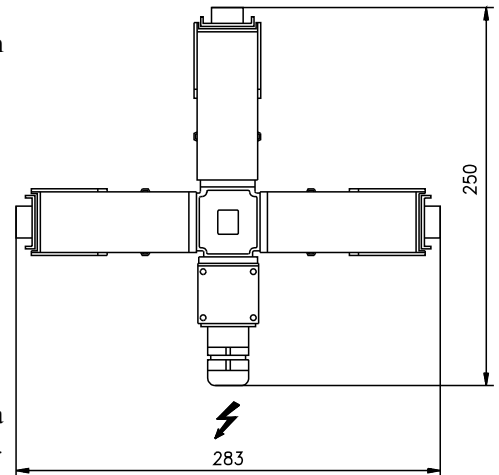

INSTALLATION PRESCRIPTIONS

The installation of bands, connections to DomoClick® connectors to connection boxes will be carried out according to the rules of the trade. Before going ahead with work on electric tracers, care will be taken to isolate them from the mains. The DomoClick® connection and junction techniques are approved if used together with self-adjusting Eltrace heating tapes. Eltrace guarantees correct working only in relation with the mentions heating tapes. Through the direct mounting onto the pipe, DomoClick® uses less heating tape. As a general rule, DomoClick® is fixed to the pipe with the supplied ligatures. DomoClick® can also be fixed to the wall with supplied stirrups. The supply cable is to be directly connected into the DomoClick®. Any exterior supply, junction or derivation box is thus avoided. In anti-frost installations for gutters, DomoClick® must not be installed in a gutter or on the roof, but in a sheltered position under the roof or eave. DomoClick® can be installed directly on pipes with a service temperature of less than 70°C. Short periods at 80°C are admitted. Important : for admitted temperatures of heating tapes, refer to the technical data DomoClick® incorporated into pipe insulation. All supply points, junctions and terminals must remain accessible. Electrical supply points and terminals must be indicated with the supplied self-adhesive labels.

QUALIFICATIONS PRODUITS

Certifications CE



DOMOCLICK® FAST CONNECTOR

DOMOCLICK® - DHB-105

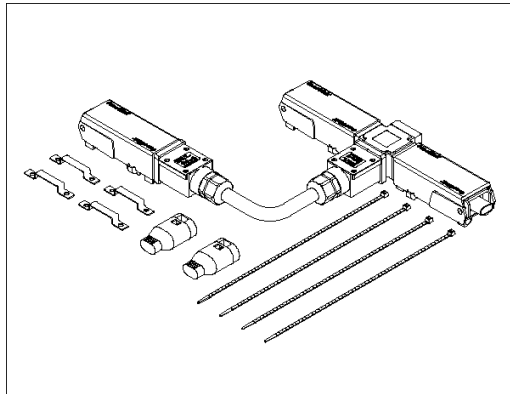

DOMOCLICK® T DERIVATION SET FOR THE JUNCTION BETWEEN THREE HEATING TAPES FOR LAYER DISTRIBUTION.
 DHB-105 DomoClick® T derivation set for the junction between three heating tapes for layer distribution. Box and cover in polyamid, Ligature, Stirrups for wall mounting CE

COMPOSITION

- T derivation
- 2 terminals
- 4 heat-resistant ligatures
- self-adhesive labels “electric supply” and “terminal”

EASY

Eltrace heating tapes are supplied and connected between themselves with a minimum of manipulations. Only a knife is needed to strip the band ends. The different clicks are made up of only three parts.

SURE

The mounting stages are visible and easily controllable. The upper and lower blades guarantee a sure contact.

FAST

It takes only a few minutes to assemble the Click, for it involves only four stages:

1. Insert the band into the cover and the metal cone
2. Strip the band end.
3. Insert the heating tape into the Click.
4. Push the lever and shut the cover.

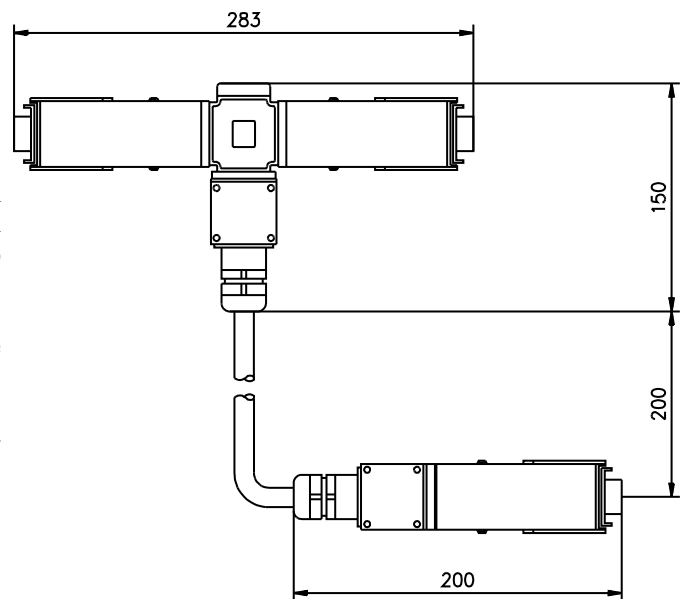

INSTALLATION PRESCRIPTIONS

The installation of bands, connections to DomoClick® connectors to connection boxes will be carried out according to the rules of the trade. Before going ahead with work on electric tracers, care will be taken to isolate them from the mains. The DomoClick® connection and junction techniques are approved if used together with self-adjusting Eltrace heating tapes. Eltrace guarantees correct working only in relation with the mentions heating tapes. Through the direct mounting onto the pipe, DomoClick® uses less heating tape. As a general rule, DomoClick® is fixed to the pipe with the supplied ligatures. DomoClick® can also be fixed to the wall with supplied stirrups. The supply cable is to be directly connected into the DomoClick®. Any exterior supply, junction or derivation box is thus avoided. In anti-frost installations for gutters, DomoClick® must not be installed in a gutter or on the roof, but in a sheltered position under the roof or eave. DomoClick® can be installed directly on pipes with a service temperature of less than 70°C. Short periods at 80°C are admitted : for admitted temperatures of heating tapes, refer to the technical data DomoClick® incorporated into pipe insulation. All supply points, junctions and terminals must remain accessible. Electrical supply points and terminals must be indicated with the supplied self-adhesive labels.

QUALIFICATIONS PRODUITS

Certifications CE



DOMOCLICK® FAST CONNECTOR

DOMOCLICK® - DHB-400



DOMOCLICK DHB-400 HEATING CABLE TERMINATION

COMPOSITION

1. Terminaison with GLUE inside; IP68
2. Self adhesive label "terminaison".

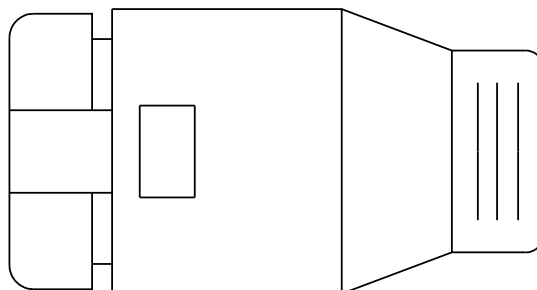

EASY

Eltrace heating tapes are supplied and connected between themselves with a minimum of manipulations. Only a knife is needed to strip the band ends. The click is made up of only two parts.

SURE

The mounting stages are visible and easily controllable.

FAST

It takes only a few second

TECHNIQUE DE RACCORDEMENT ET DE JONCTION CLASSIQUE

Boîte de Raccordement / Jonction

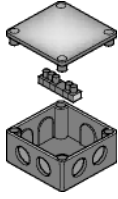

ELBE-3 - BOITE DE RACCORDEMENT / JONCTION

Boîte de jonction en polycarbonate, étanchéité IP54, dimensions 89 x 89 x 44 mm opercules défonçables taraudés PG16, barrette de connexion 5 x 4 mm²

ELBE-8 - BOITE DE RACCORDEMENT / JONCTION

Boîte de jonction en polycarbonate, étanchéité IP65, dimensions 125 x 125 x 75 mm, 4 opercules défonçables fl 15,5 et 21 et 4 opercules défonçables fl 23 et 29, bornes de phase 10 mm² et borne de terre 6 mm² sur rail DIN

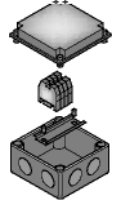

Support de Boîte



ELSP

Support de boîte à entrée directe pour ELBE-3

ELSP-1

Support de boîte à entrée directe pour ELBE-8

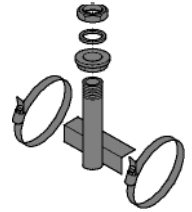

Sortie de calorifuge



ELSC

Sortie de calorifuge avec gaine de protection

ELSC-E

Sortie de calorifuge standard

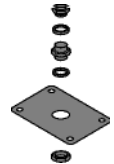

Kit de terminaisons



ELKSR-1

Kit de terminaison pour la réalisation d'un élément complet

Jonction en ligne

ELJL

Jonction en ligne sous calorifuge



Tableau d'équivalence entre les systèmes DomoClick® et classiques

DOMOCLICK

SYSTÈME CLASSIQUE

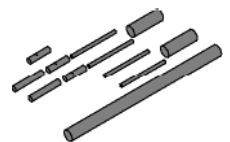
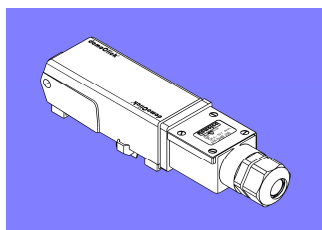

DHB-100

ELBE-3 + 1 ELKSR-1 (+ 1 ELSP option)
ou
ELBE-8 + 1 ELKSR-1 (+ 1 ELSP-1 option)

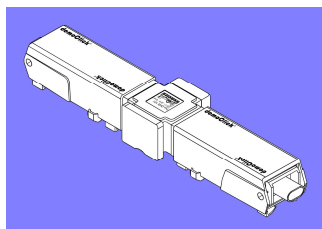

DHB-101

ELBE-3 + 2 ELKSR-1 (+ 1 ELSP option)
ou
ELBE-8 + 2 ELKSR-1 (+ 1 ELSP-1 option)
ou
ELJL

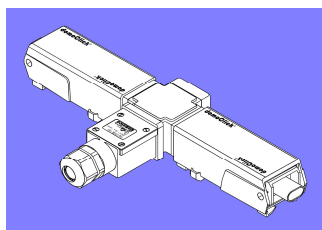

DHB-102

ELBE-3 + 2 ELKSR-1 (+ 1 ELSP option)
ou
ELBE-8 + 2 ELKSR-1 (+ 1 ELSP-1 option)

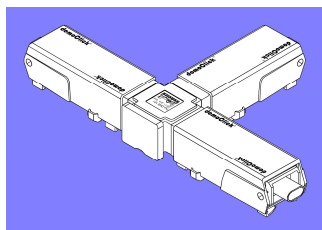

DHB-103

ELBE-3 + 3 ELKSR-1 (+ 1 ELSP option)
ou
ELBE-8 + 3 ELKSR-1 (+ 1 ELSP-1 option)

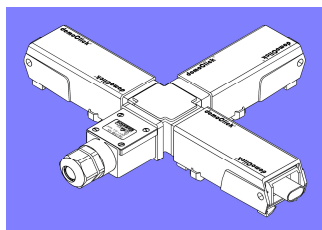





DHB-104

ELBE-3 + 3 ELKSR-1 (+ 1 ELSP option)
ou
ELBE-8 + 3 ELKSR-1 (+ 1 ELSP-1 option)

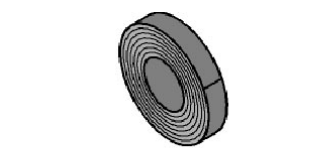
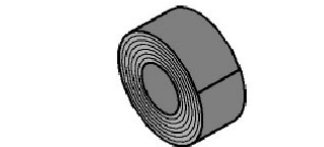
SYSTÈME DE TRAÇAGE ÉLECTRIQUE

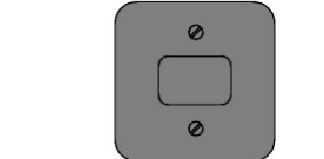
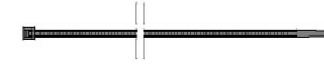
Accessoires

	DHB 403	Ligatures pour la fixation du ruban chauffant sur la conduite	Ligatures résistantes à la chaleur 100 pces/sachet. Intervalle de fixation conseillé 30 cm
	ELTV	Ruban adhésif textile pour la fixation du ruban chauffant sur la conduite	Ruban adhésif textile 20 m/rouleau Intervalle de fixation conseillé 30cm
	ELAA 50	Bande adhésive en aluminium pour fixation du ruban chauffant (p.ex. sur conduites en plastique)	Bande adhésive en aluminium longueur 50 m/largeur 50 mm
	DHB 400	DomoClick terminaison de ruban chauffant	Terminaison Autocollant "terminaison"
	ELET	Autocollant pour la signalisation des conduites équipées de ruban chauffant, à placer sur l'isolation	Autocollant « Traçage électrique » Intervalle de fixation 5 m résistant aux UV et à la pluie.
	DHB 413	Interrupteur manuel pour petites installations jusqu'à env. 10 m, non équipées d'un détecteur de gel	Interrupteur manuel avec voyant de contrôle
	DHB 404	Ligatures noires résistant aux UV pour la fixation du ruban chauffant	Ligatures noires 100 pces/sachet.
	DHB-409	Système de fixation pour chéneaux et gouttière	Pattes inox pré-perçées dimensions : 300 x 25mm
	DHB 410	Protection de jointure pour panneaux ondulés.	Protection de naissance 2 ligatures

INSTRUCTIONS DE MONTAGE

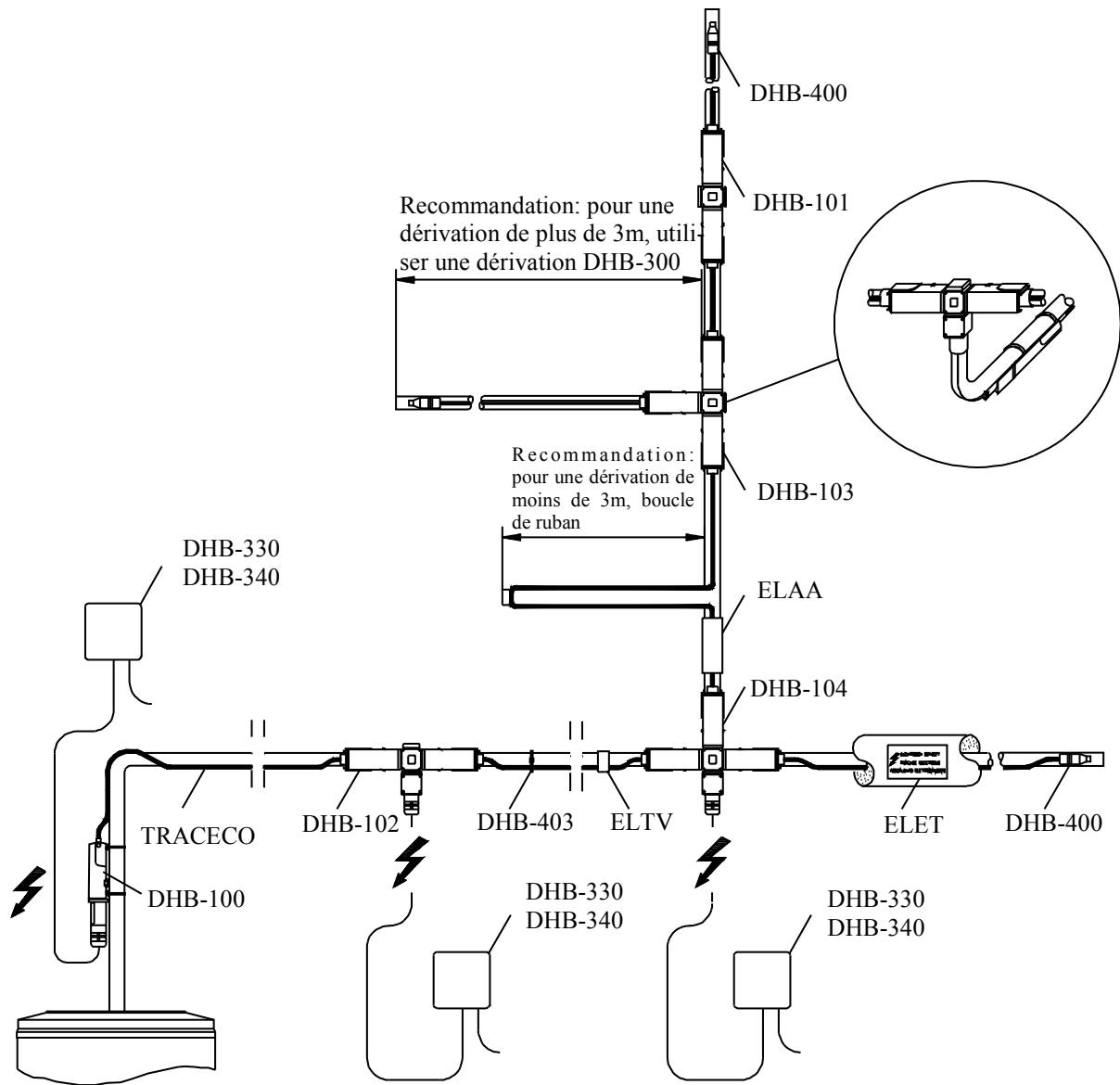

Alimentation Variante 1
Au début/A la fin du ruban chauffant

Alimentation Variante 2
Sut la conduite, près d'une alimentation électrique

Alimentation Variante 3
A l'endroit d'une dérivation

DHB 100 DomoClick® set de raccordement avec alimentation électrique
DHB 101 DomoClick® set de jonction
DHB 102 DomoClick® set de jonction avec alimentation électrique
DHB 103 DomoClick® dérivation en T
DHB 104 DomoClick® dérivation en T avec alimentation électrique

DHB 105 DomoClick® dérivation en T pour distribution en nappes
DHB 330 Régulateur de puissance Therm-Control
DHB 340 Thermostat Frost-Control
DHB 400 DomoClick® terminaison (livrée avec chaque DomoClick®)

ELTV Ruban adhésif textile
ELAA Bande adhésive en aluminium
ELET Autocollant "Traçage électrique"

INSTRUCTIONS DE MONTAGE

Antigel et distribution d'eau chaude

Position du ruban chauffant sur la conduite

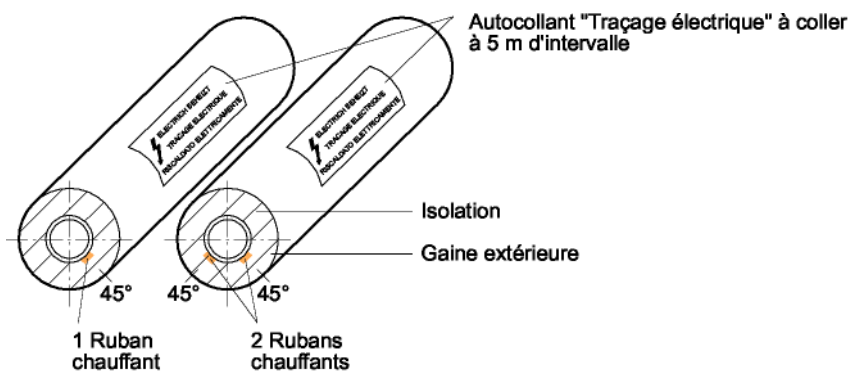

Fixation sur conduites métalliques

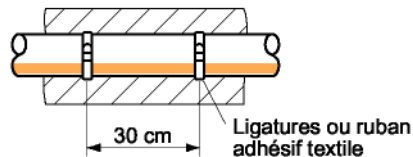

Fixation sur conduites en plastique

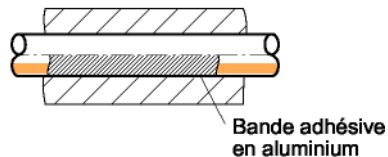

Lors d'utilisation de colliers anti-bruit, découper l'isolation phonique au passage du ruban chauffant.

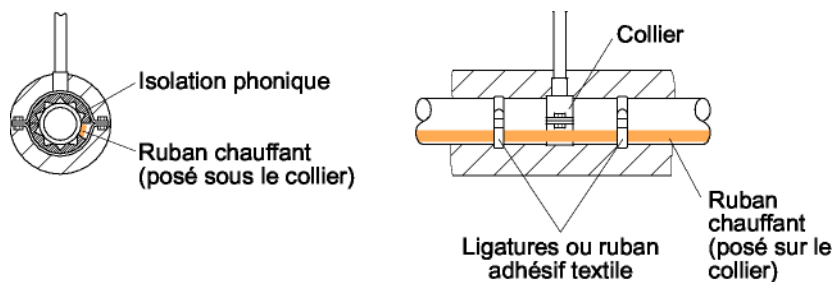

Poser toujours le ruban chauffant à l'extérieur des coudes

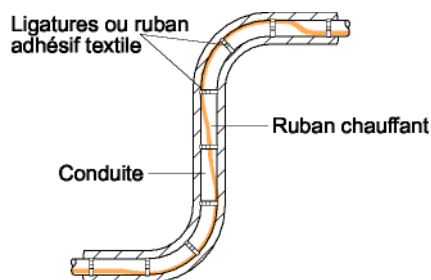

INSTRUCTIONS DE MONTAGE

Les raccordements et jonctions DomoClick® ne doivent pas être installés dans les chéneaux ou sur les toits, mais à l'abri dans la sous-toiture ou sous l'avant-toit.

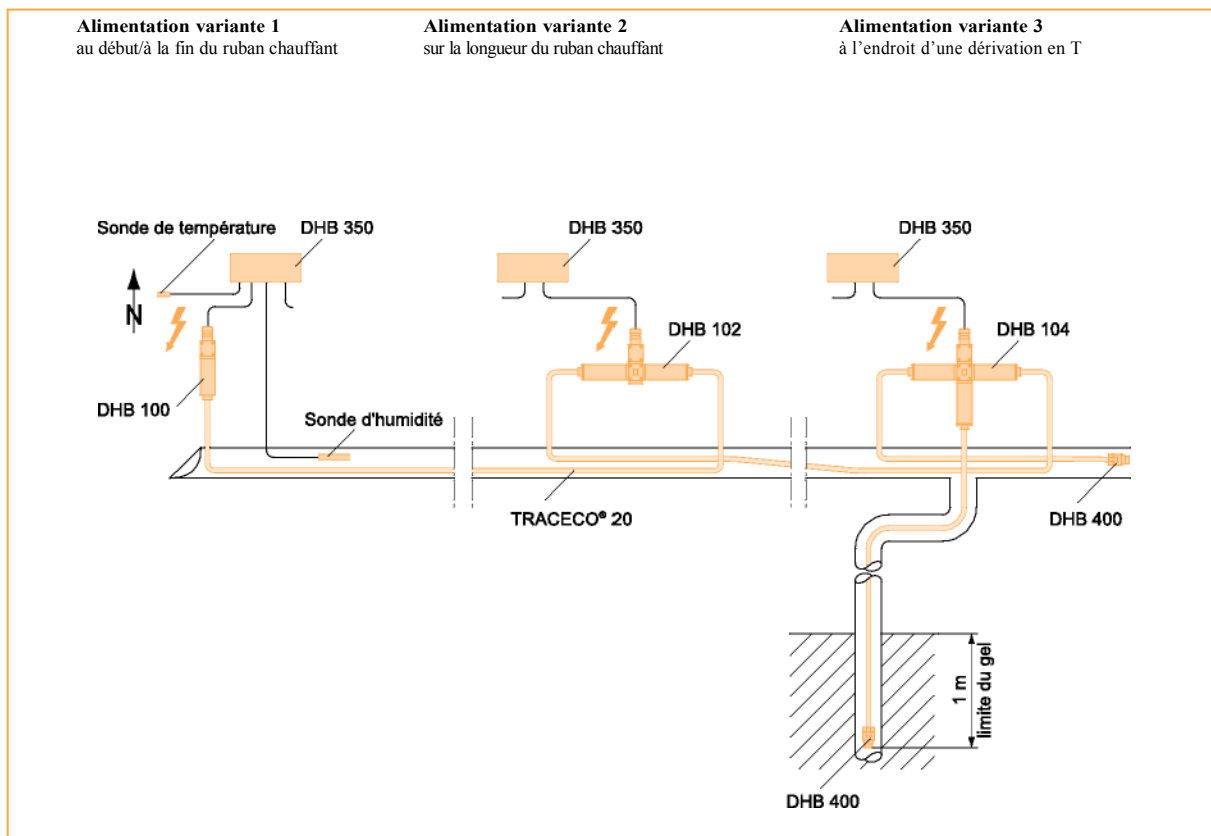

DHB 100 DomoClick® set de raccordement avec alimentation électrique
DHB 101 DomoClick® set de jonction
DHB 102 DomoClick® set de jonction avec alimentation électrique

DHB 103 DomoClick® dérivation en T
DHB 104 DomoClick® dérivation en T avec alimentation électrique
TRACECO®-20 Ruban chauffant
DHB 350 Détecteur de gel Ice- Control

DHB 400 DomoClick terminaison (contenue dans chaque DomoClick®)
DHB 409 Protection de naissance, Support

INSTRUCTIONS DE MONTAGE

Montage sur une naissance de descente

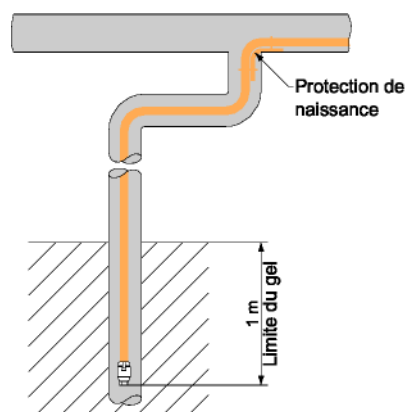

Montage dans des sheds ou toits plats

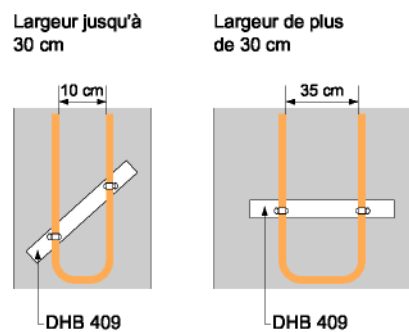

Montage aux crochets à neige pour protection d'avant-toit

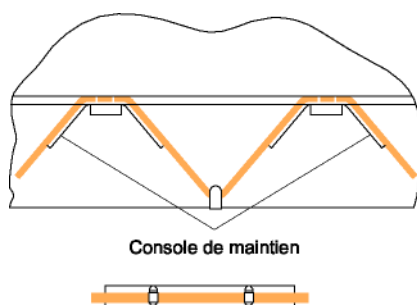

Montage sur toits en panneaux ondulés

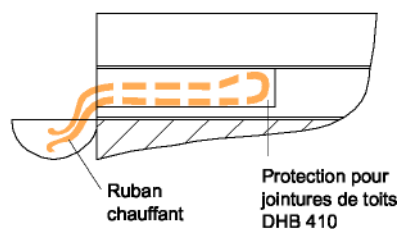

INSTRUCTIONS DE MONTAGE

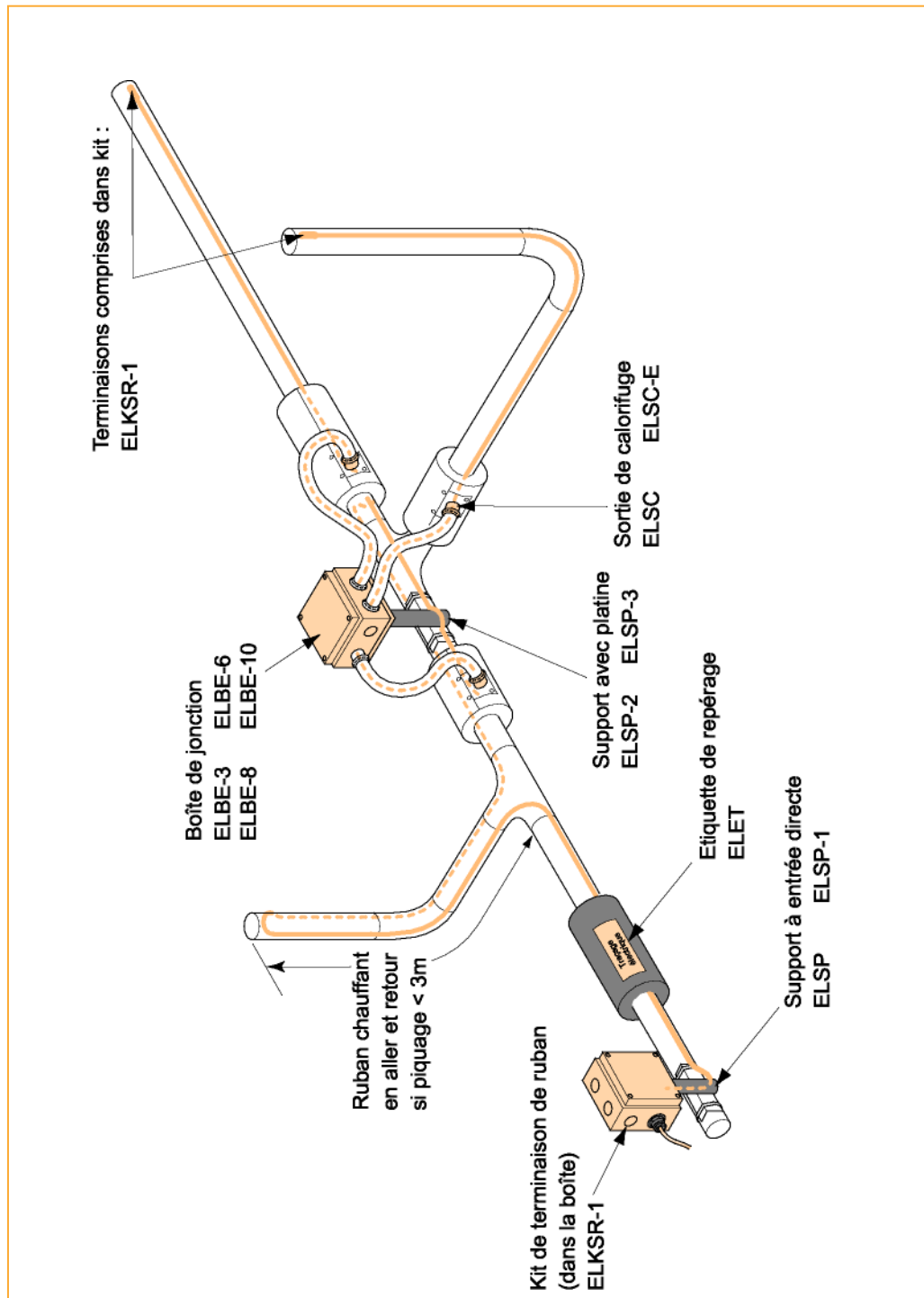

MISE EN SERVICE ET MAINTENANCE**INFORMATION GÉNÉRALE**

Ce guide est conçu uniquement pour le fonctionnement et l'entretien des rubans chauffants électriques autorégulants sur les canalisations et appareils calorifugés.

Pour toute information relative à d'autres applications, veuillez contacter votre Agent ELTRACE ou téléphoner au +33 (0) 164 620 440.

MISE EN OEUVRE

Notre matériel devra être installé conformément à nos instructions de montage et aux spécifications définies lors de l'étude de l'installation.

L'installation doit être conforme aux normes en vigueur NF C 15-100.

ALIMENTATION ET PROTECTION ÉLECTRIQUE

Tension d'alimentation : 230 V

Les protections électriques seront assurées par disjoncteur différentiel 30 mA ou 300 mA à courbe C ou D. Le calibre de ces derniers devra être défini en fonction du nombre de circuits qu'ils protègent.

Nombre de circuits maxi par disjoncteur : 3

Mise en service.

ESSAIS

Après avoir terminé l'installation des rubans chauffants, vérifier la résistance d'isolement de chaque circuit entre les fils conducteurs et la tresse métallique ou la tuyauterie métallique à l'aide d'un mégohmmètre 500 VCC mini.

FONCTIONNEMENT ET MAINTENANCE**ESSAIS**

La température d'exposition ne doit pas dépasser celle spécifiée dans la documentation technique du produit. Dépasser les limites, c'est raccourcir la durée de vie du ruban et risquer d'endommager de façon permanente le ruban chauffant.

Le calorifuge doit être complet et sec pour maintenir à la bonne température.

INSPECTION PÉRIODIQUE

Inspecter visuellement et périodiquement le ruban chauffant et le calorifugeage pour s'assurer qu'il n'y a aucun dommage mécanique.

Contrôler régulièrement la résistance d'isolement. Les installations mises hors gel doivent être vérifiées chaque année avant l'hiver. Dans le cas d'un maintien en température, une vérification doit avoir lieu deux fois par an.

Vérifier régulièrement le bon fonctionnement des protections et des thermostats.

RÉPARATION ET ENTRETIEN DES TUYAUTERIES

Déconnecter le ruban chauffant et le protéger de toute agression mécanique ou thermique pendant les travaux de réparation de tuyauterie. Vérifier l'installation du ruban chauffant après réparation de la tuyauterie et remettre le calorifuge en place. S'assurer du bon fonctionnement des protections électriques.

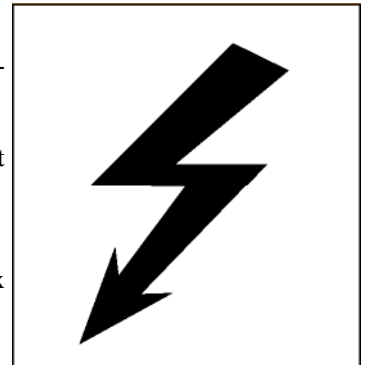

Sets de raccordement et avec alimentation électrique

DHB 100

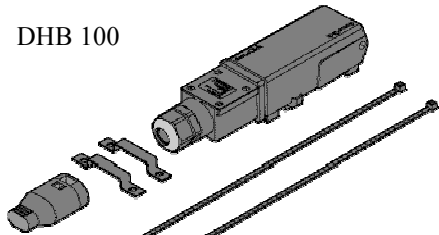

DomoClick set de raccordement avec alimentation électrique pour la jonction entre ruban chauffant et câble d'alimentation.

Boîte d'alimentation électrique intégrée
1 terminaison
2 ligatures résistantes à la chaleur
2 étriers pour montage mural
Autocollants « alimentation électrique » et « terminaison »

DHB 102

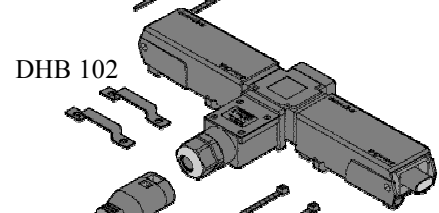

DomoClick set de jonction avec alimentation électrique pour la jonction entre deux rubans chauffants et câble d'alimentation.

Boîte d'alimentation électrique intégrée
2 terminaisons
2 ligatures résistantes à la chaleur
2 étriers pour montage mural
Autocollants « alimentation électrique » et « terminaison »

DHB 104

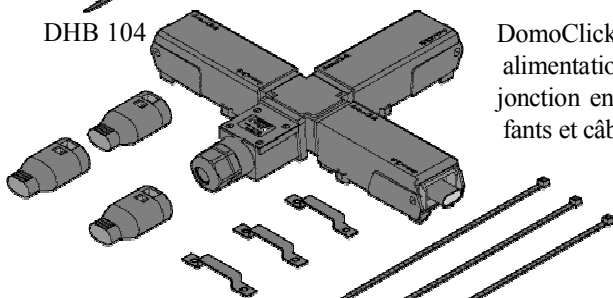

DomoClick dérivation en T avec alimentation électrique pour la jonction entre trois rubans chauffants et câble d'alimentation.

Dérivation en T avec boîte d'alimentation électrique
3 terminaisons
3 ligatures résistantes à la chaleur
3 étriers pour montage mural
Autocollants « alimentation électrique » et « terminaison »

Sets de jonctions

DHB -101

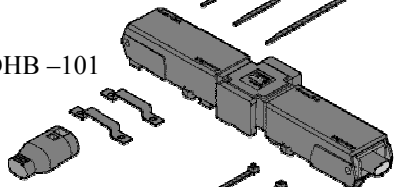

DomoClick set de jonction pour la jonction entre deux rubans chauffants (p.ex.pour extension d'un circuit)

Jonction
1 terminaison
2 ligatures résistantes à la chaleur
2 étriers pour montage mural
Autocollants « alimentation électrique » et « terminaison »

DHB-103

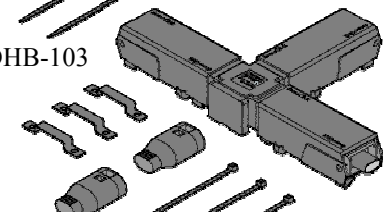

DomoClick dérivation en T pour la jonction entre trois rubans chauffants (par exemple pour dérivation en T ou extension d'un circuit)

Dérivation en T
2 terminaisons
3 ligatures résistantes à la chaleur
3 étriers pour montage mural
Autocollants « alimentation électrique » et « terminaison »

DHB 105

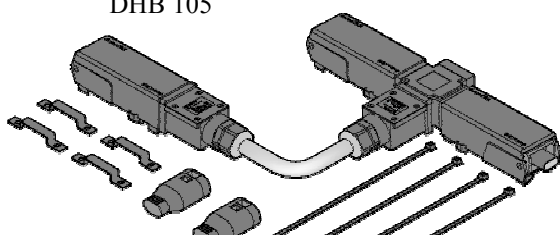

DomoClick dérivation en T pour la jonction entre trois rubans chauffants pour distributions en nappes

Dérivation en T
2 terminaisons
4 ligatures résistantes à la chaleur
Autocollants « alimentation électrique » et « terminaison »

ELTRACESERVICES

Fidèle à notre vocation, le Service constitue un axe prioritaire de notre métier. Depuis la conception de l'installation jusqu'à la maintenance, vous disposez d'une « Garantie clefs-en main » intégrant les études, la pose, l'isolation thermique, les performances attendues, la formation.

Notre équipe de spécialistes vous conseille et vous accompagne tout au long de votre projet.

ELTRACE S'ENGAGE

Véritable Code de Conduite, nos 7 engagements constituent le gage de la fiabilité et de la sécurité de nos prestations et de nos produits.



1- ECOUTE

Impliqués dans votre métier, nos spécialistes réalisent un diagnostic précis de votre installation.



2- MAÎTRISE DES COÛTS

Nous recherchons les solutions techniques les plus conformes à la maîtrise de vos coûts en adéquation avec vos exigences.



3- RÉACTIVITÉ

Réagir à tout imprévu ou modification nécessaire... nos équipes s'adaptent à ces contraintes.

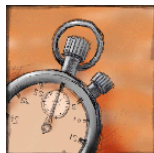

4- RESPECT DES DÉLAIS

Nous nous engageons sur le respect des délais jusqu'à la réception des produits ou des travaux.



5- QUALITÉ

Nous garantissons des produits testés et conformes à vos exigences et à la réglementation en vigueur.



6- ENVIRONNEMENT

Tous nos process intègrent les exigences de l'Environnement tant sur le plan humain que technique.



7- GARANTIE DE PERFORMANCE

Dès la conception du projet, nous garantissons les performances et les résultats attendus.

ELTRACEPARTNER

VOTRE PARTENAIRE TRAÇAGE ÉLECTRIQUE

Disponible chez votre distributeur